

2MP ColourHunter Fixed Turret Analog Camera

UAC-T112-F28(40)-W



Introduction

UAC-T112-F28/F40-W is a 2MP ColourHunter Fixed Turret Analog Camera with a high-performance 1/3-inch CMOS sensor. It supports TVI/AHD/CVI/CVBS, which effectively enhances product adaptability and diversity of networking solutions. With SYV-75-3 or other coaxial cable types the camera can achieve low-cost, long-distance, anti-interference, and low delay mega-pixel HD video transmission. The camera supports 24/7 full-color imaging.

Features

- 2MP high quality image
- TVI/AHD/CVI/CVBS
- Supports white light illumination, 24/7 full-color imaging
- Supports 180° horizontal flip, 180° vertical flip
- OSD configuration menu, easy to operate
- IP67 waterproof and dustproof design, high reliability
- OSD configuration menu in 11 languages
- 3-Axis

Specifications

Model	UAC-T112-F28-W	UAC-T112-F40-W
Sensor		
Pixel	2MP	
Size	1/3"	
Minimum illumination	0.01lux (F1.6, AGC ON) 0 lux (white light on)	
Lens		
Lens	2.8mm	4.0mm
Lens mount	M12	
Angle of view	H: 100.9° V: 56.5° D: 121.8°	H: 82.5° V: 42.1° D: 98.6°
Illuminator		
Illuminator	One white-light illuminator	
Illumination distance	20m	
Lifetime	≥60,000 hours	
Video		
Resolution	1080P: 1920(H)×1080(V) 720P: 1280(H) ×720(V)	
Frame rate	TVI/AHD/CVI: 1080P@30fps, 1080P@25fps; 720P@30fps, 720P@25fps CVBS: PAL, NTSC	
Shutter time	PAL: 1/25s-1/50000s NTSC: 1/30s-1/50000s	
Image		
Exposure mode	4 modes: Global (default), BLC, HLC, DWDR	
Day/Night	24/7 full-color imaging	
Digital noise reduction	2D/3D	
White balance	Two modes: Auto (default), Manual	
WDR	DWDR	
Flip	Supports 180° horizontal flip, 180° vertical flip	
Interface		
Power	5.5mm power interface	
Video output	BNC, supports TVI/AHD/CVI/CVBS	
Operating environment		
Temperature	-30°C to 60°C(-22°F to 140°F)	
Humidity	≤95% (RH, non-condensing)	
Surge protection	4KV	
General		
Power	DC 12V(±25%), with reverse polarity protection, Max 2.4W	
Mount	Surface mount (default), optional backbox, wall mount bracket	
Dimensions	Φ118mm*96mm (diameter*height)	
Material	Plastic	
Weight	205g(0.452lb)	
OSD menu language	11 Languages English, German, Spanish(Latin America), French, Italian, Japanese, Korean, Polish, Portuguese(Brazil),	

	Russian, Turkish
Certification	
EMC	CE-EMC (EN 55032,EN 61000-3-3,EN IEC 61000-3-2,EN 55035) FCC (FCC 47 CFR part15 B)
Safety	CE-LVD (EN 62368-1)
Environment	CE-RoHS (2011/65/EU;(EU)2015/863); WEEE (2012/19/EU)
Protection	IP67 (IEC 60529)

Dimensions

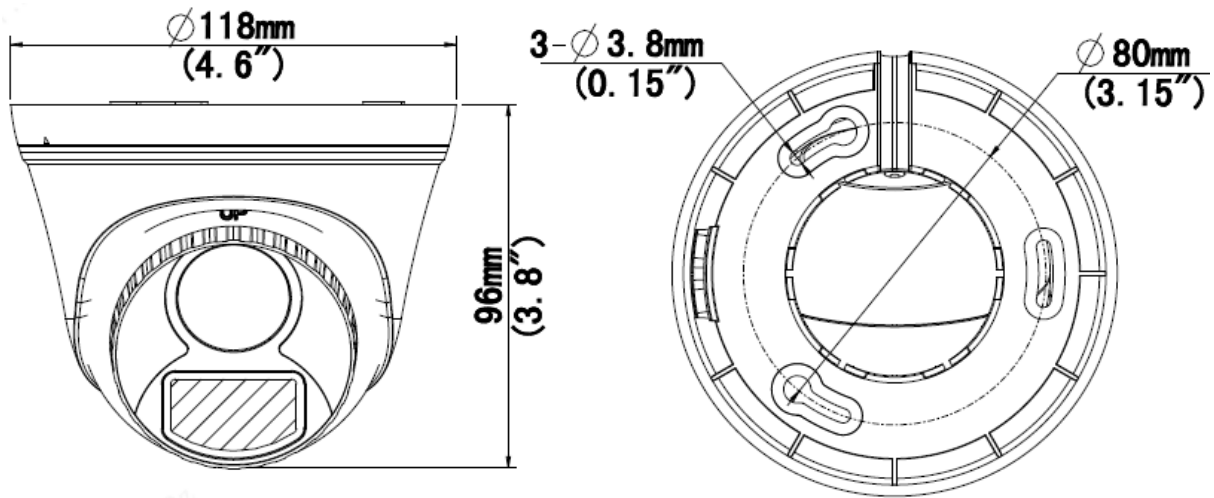

UAC-T112-F28(40)-W

Accessories

TR-JB03-I-IN

Junction Box



TR-UP06-IN

Pole Mount

TR-JB07/WM03-G-IN

Wall Mount



TR-UC08-C

Corner Mount

TR-WM03-D-IN

Wall Mount

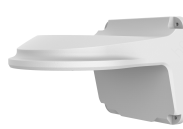

TR-SE24-A-IN

Pendant Mount

TR-WM07P-B

Wall Mount



TR-CM24-IN

Pendant Mount

TR-A01-IN

Waterproof Joint



TR-SE24-IN

Pendant Mount

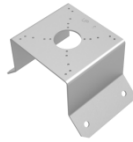

PWR-DC1201A-UK,
PWR-DC1201B-UK

PWR-DC1201A-US,
PWR-DC1201B-US

PWR-DC1201A-EU,
PWR-DC1201B-EU

PWR-DC1201A-IND

Wall Plug-in UK
Power Adapter

Wall Plug-in US
Power Adapter

Wall Plug-in EU
Power Adapter

Wall Plug-in IND
Power Adapter



Mount

TR-JB07/WM03-G-IN(TR-WM03-D-IN)+TR-UP06-IN

TR-JB03-I-IN

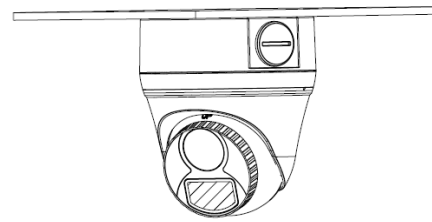
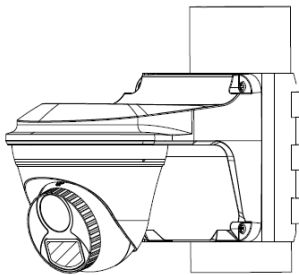

11:33:50

TR-JB07/WM03-G-IN(TR-WM03-D-IN)+TR-UC08-C

TR-CM24-IN+TR-JB03-I-IN

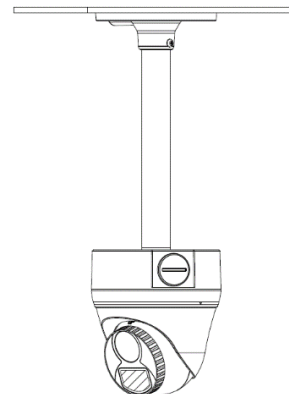
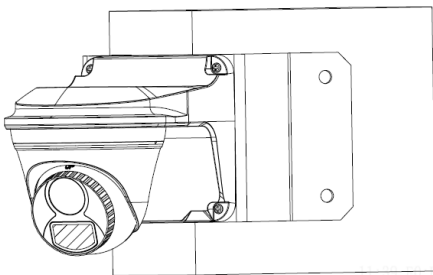

TR-WM07P-B

TR-JB07/WM03-G-IN(TR-WM03-D-IN)

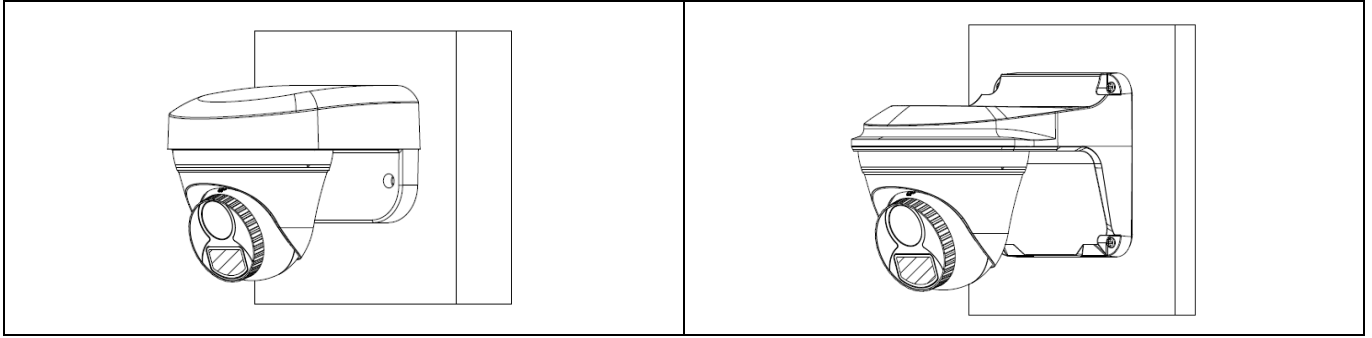

Zhejiang Uniview Technologies Co., Ltd.

Building No. 369, Xietong Road, Xixing Sub-district, Binjiang District, Hangzhou City, Zhejiang Province, China (310051)

Email: overseasbusiness@uniview.com; globalsupport@uniview.com

<https://www.uniview.com>

©2022 Zhejiang Uniview Technologies Co., Ltd. All rights reserved.

*Product specifications and availability are subject to change without notice.